



STUART GARDEN ARCHITECTURE

*Burrow Hill Farm,
Wiveliscombe
Somerset, TA4 2RN, UK*

*Tel: 01984 667458
Fax: 01984 667455
Email: sales@stuartgarden.com
www.stuartgarden.com*

Product catalogue and specifications



STUART GARDEN ARCHITECTURE
Product catalogue and specifications

trelliswork
planters
obelisks
gazebos
pergolas
arbours
benches
gates
bridges



TRELLIS COMPONENTS SQUARE MODULAR

152mm (6in) centres square jointed panels

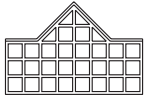

4GT gothic header panel
1245 x 840mm (4ft 1in x 2ft 9in)



4ST curved header panel
1245 x 635mm (4ft 1in x 2ft 1in)

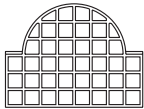

4LT curved header panel
1245 x 940mm (4ft 1in x 3ft 1in)



4CCT curved header panel
1245 x 480mm (4ft 1in x 1ft 7in)

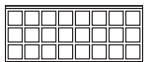

4TT header panel
1245 x 502mm (4ft 1in x 1ft 8in)

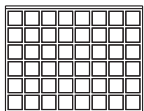

4PTB planter base panel / dado panel
1245 x 965mm (4ft 1in x 3ft 2in)

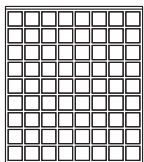

4TB base panel
1245 x 1420mm (4ft 1in x 4ft 8in)



2DB/L drop curve panel
635 x 1420mm (2ft 1in x 4ft 8in)



2DB/R drop curve panel
635 x 1420mm (2ft 1in x 4ft 8in)



2RPT curved header panel
635 x 480mm (2ft 1in x 1ft 7in)



2TT header panel
635 x 502mm (2ft 1in x 1ft 8in)

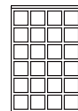

2PTB planter base panel / dado panel
635 x 965mm (2ft 1in x 3ft 2in)

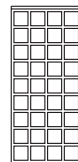

2TB base panel
635 x 1420mm (2ft 1in x 4ft 8in)

4DT/R curved header panel
785 x 502mm (2ft 7in x 1ft 8in)



4DT/L curved header panel
785 x 502mm (2ft 7in x 1ft 8in)

2RT/R drop curve panel
635 x 965mm (2ft 1in x 3ft 2in)



2RT/L drop curve panel
635 x 965mm (2ft 1in x 3ft 2in)

4RT/R drop curve panel
1245 x 965mm (4ft 1in x 3ft 2in)

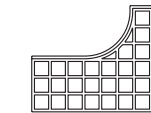
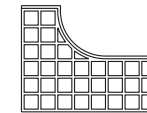

4RT/L drop curve panel
1245 x 965mm (4ft 1in x 3ft 2in)

4RB/R drop curve panel
1245 x 1420mm (4ft 1in x 4ft 8in)

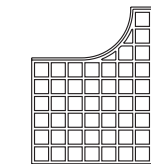
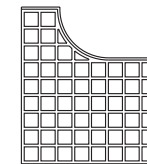

4RB/L drop curve panel
1245 x 1420mm (4ft 1in x 4ft 8in)

4DB/R drop curve panel
1245 x 1420mm (4ft 1in x 4ft 8in)

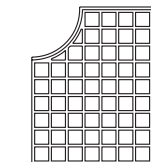
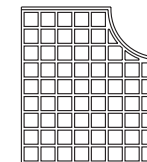

4DB/L drop curve panel
1245 x 1420mm (4ft 1in x 4ft 8in)

NB. Measurements are shown width x height x depth (where appropriate)

TRELLIS COMPONENTS SQUARE MODULAR

152mm (6in) centres square jointed panels

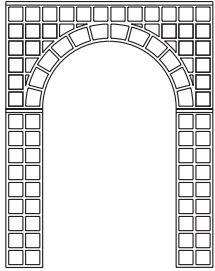

6CRA 6ft complete roman arch
(requires 3.5m posts)
1855 x 2385mm (6ft 1in x 7ft 10in)

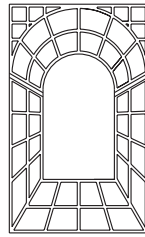

4PI perspective illusion panel
1245 x 2055mm (4ft 1in x 6ft 9in)

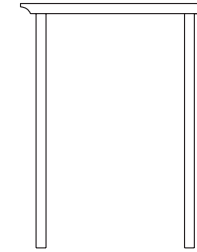

4PLA post and lintel arch
opening width 1245mm (4ft 1in)
overall height 2340mm (7ft 8in)

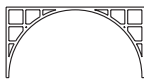

4SC semi-circular arch panel
1245 x 635mm (4ft 1in x 2ft 1in)

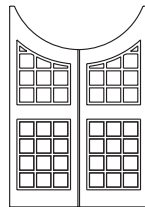

4MG (pair) 4ft moon gates
(including standard hardware)
1240 x 1800 x 44mm
(4ft 1in x 5ft 10in x 1 3/4in)

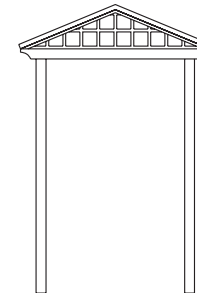

4CPA complete classical arch
opening width 1245mm (4ft 1in)
overall height 2600mm (8ft 6in)

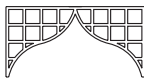

4SA gothic arch panel
1245 x 635mm (4ft 1in x 2ft 1in)

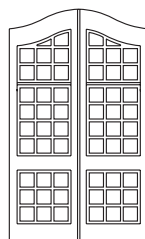

4SG (pair) 4ft serpentine gates
(including standard hardware)
1240 x 2055 x 44mm
(4ft 1in x 6ft 9in x 1 3/4in)

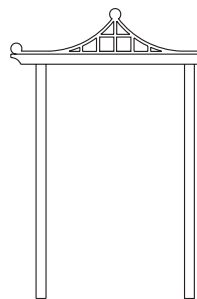

4CHP complete chinese arch
opening width 1245mm (4ft 1in)
overall height 2600mm (8ft 6in)

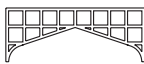

4GA arch panel
1245 x 480mm (4ft 1in x 1ft 7in)

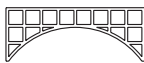

4CCT curved header panel
1245 x 480mm (4ft 1in x 1ft 7in)



4GPA arch panel
1245 x 840mm (4ft 1in x 3ft)

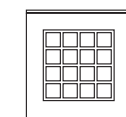

HG3 3ft hampton court gate
(including standard hardware)
940 x 965 x 44mm
(3ft 1in x 3ft 2in x 1 3/4in)

NB. Measurements are shown width x height x depth (where appropriate)

TRELLIS COMPONENTS SQUARE MODULAR

152mm (6in) centres square jointed panels

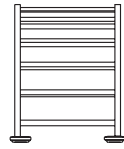
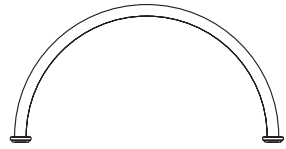

6RA 6ft classical rose arch top (including post caps)
 2033 x 1060 x 813mm (6ft 8in x 3ft 6in x 2ft 8in)
 Internal width 1855mm (6ft 1in)
 Overall depth 813mm (2ft 8in)

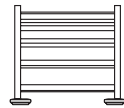
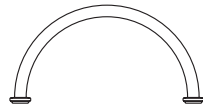

4RA 4ft classical rose arch top (including post caps)
 1423 x 755 x 813mm (4ft 8in x 2ft 6in x 2ft 8in)
 Internal width 1245mm (4ft 1in)
 Overall depth 813mm (2ft 8in)

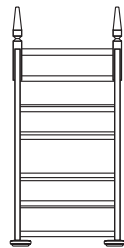
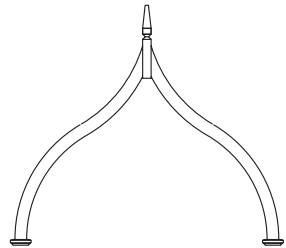

6GRA 6ft gothic rose arch top (including post caps)
 2033 x 1845 x 813mm (6ft 8in x 6ft 6in x 2ft 8in)
 Internal width 1855mm (6ft 1in)
 Overall depth 813mm (2ft 8in)

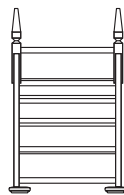
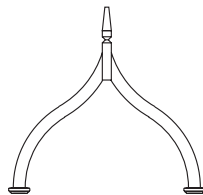

4GRA 4ft gothic rose arch top (including post caps)
 1423 x 1408 x 813mm (4ft 8in x 4ft 7in x 2ft 8in)
 Internal width 1245mm (4ft 1in)
 Overall depth 813mm (2ft 8in)

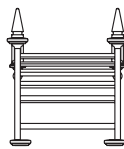
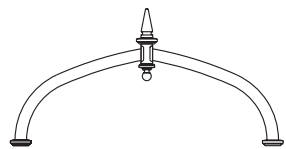

6TGA 6ft tudor gothic arch top (including post caps)
 2033 x 1060 x 813mm (6ft 8in x 3ft 6in x 2ft 8in)
 Internal width 1855mm (6ft 1in)
 Overall depth 813mm (2ft 8in)

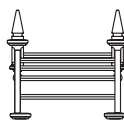
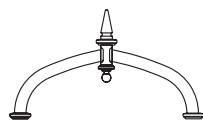

4TGA 4ft tudor gothic arch top (including post caps)
 1423 x 843 x 813mm (4ft 8in x 2ft 9in x 2ft 8in)
 Internal width 1245mm (4ft 1in)
 Overall depth 813mm (2ft 8in)

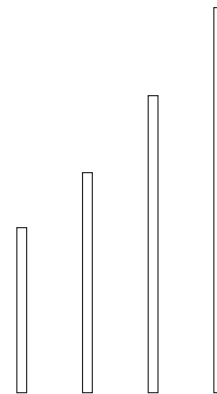

PO/90/1.5 89mm section post

89 x 1500 x 89mm (3 3/4in x 4ft 11in x 3 3/4in)

PO/90/2 89mm section post

89 x 2040 x 89mm (3 3/4in x 6ft 9in x 3 3/4in)

PO/90/2.7 89mm section post

89 x 2750 x 89mm (3 3/4in x 9ft x 3 3/4in)

PO/90/3.5 89mm section post

89 x 3500 x 89mm (3 3/4in x 11ft 6in x 3 3/4in)

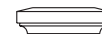

PC/90 post cap for PO/90

160 x 45 x 160mm
 (6 1/2in x 2in x 6 1/2in)



AF/90/PC acorn finial and post cap for PO/90

160 x 205 x 160mm
 (6 1/2in x 8in x 6 1/2in)



MF/90/PC mushroom finial and post cap for PO/90

160 x 126 x 160mm
 (6 1/2in x 5in x 6 1/2in)



VF/90/PC vase finial and post cap for PO/90

160 x 246 x 160mm
 (6 1/2in x 10in x 6 1/2in)



BF/90/PC ball finial and post cap for PO/90

160 x 170 x 160mm
 (6 1/2in x 7in x 6 1/2in)

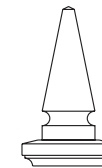

OF/90/PC obelisk finial and post cap for PO/90

160 x 275 x 160mm
 (6 1/2in x 11in x 6 1/2in)

NB. Measurements are shown width x height x depth (where appropriate)

TRELLIS SCHEMES SQUARE MODULAR

152mm (6in) centres square jointed panels

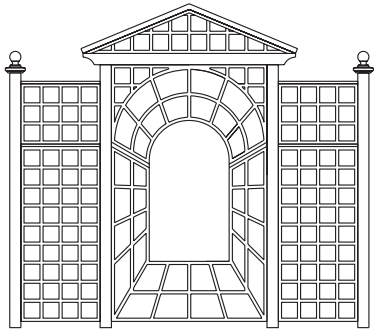

perspective illusion screen 2.9m length
152mm (6in) centres square jointed
24 x 22mm batten half-lap jointed

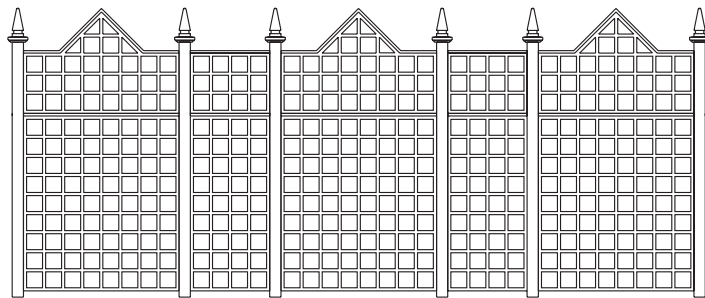

elizabethan screen 5.5m length
152mm (6in) centres square jointed
24 x 22mm batten half-lap jointed

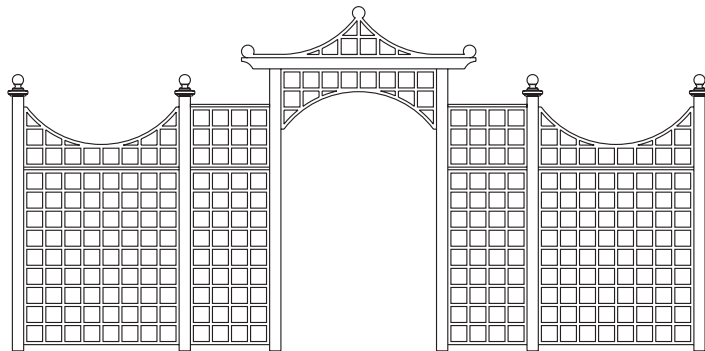

chinese arch screen 5.5m length
152mm (6in) centres square jointed
24 x 22mm batten half-lap jointed

example of how to build a scheme

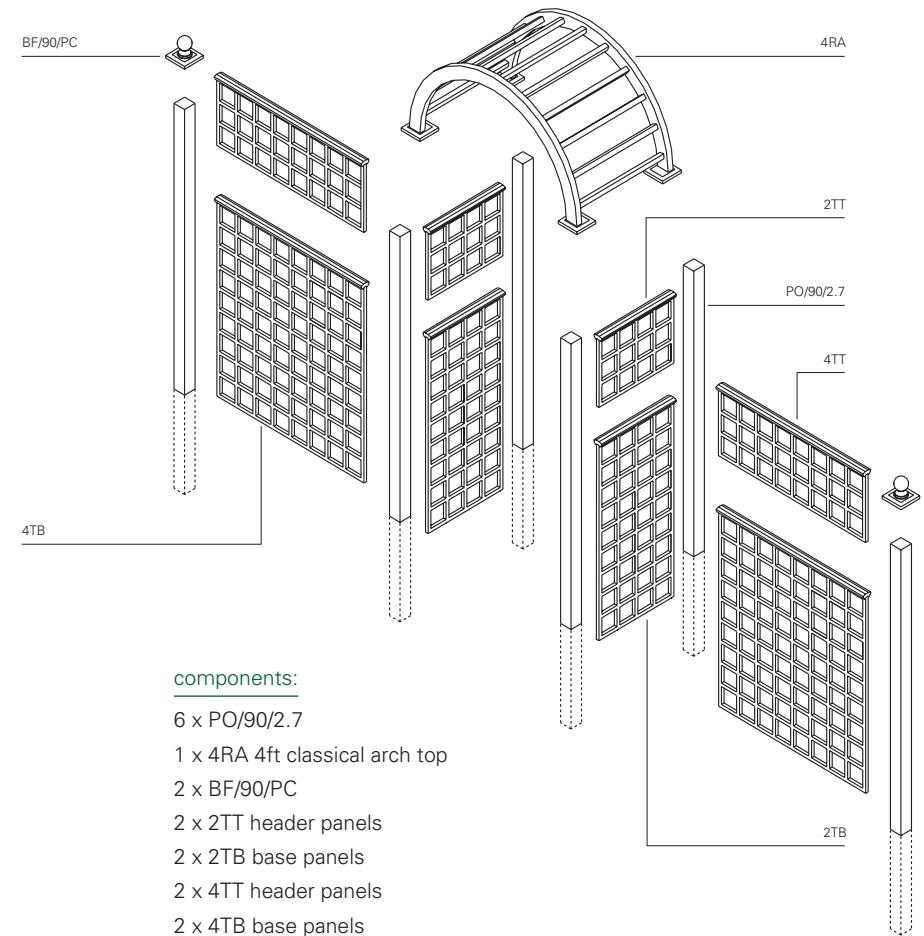

NB. Measurements are shown width x height x depth (where appropriate)

TRELLIS COMPONENTS DIAMOND MODULAR

100mm (4in) centres diamond overlap

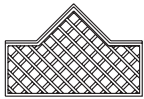

D-4GT diamond gothic header panel
1245 x 840mm (4ft 1in x 2ft 9in)

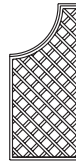

D-2DB/L diamond drop curve panel
635 x 1420mm (2ft 1in x 4ft 8in)

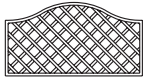

D-4ST diamond curved header panel
1245 x 635mm (4ft 1in x 2ft 1in)

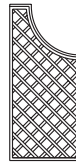

D-2DB/R diamond drop curve panel
635 x 1420mm (2ft 1in x 4ft 8in)

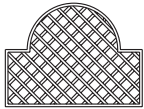

D-4LT diamond curved header panel
1245 x 940mm (4ft 1in x 3ft 1in)

D-4DT/R diamond curved header panel
785 x 502mm (2ft 7in x 1ft 8in)



D-4DT/L diamond curved header panel
785 x 502mm (2ft 7in x 1ft 8in)



D-4CCT diamond curved header panel
1245 x 480mm (4ft 1in x 1ft 7in)



D-2RPT diamond curved header panel
635 x 480mm (2ft 1in x 1ft 8in)

D-4RT/R diamond drop curve panel
1245 x 965mm (4ft 1in x 3ft 2in)

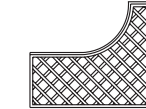
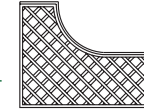

D-4RT/L diamond drop curve panel
1245 x 965mm (4ft 1in x 3ft 2in)

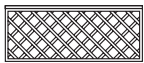

D-4TT diamond header panel
1245 x 502mm (4ft 1in x 1ft 8in)



D-2TT diamond header panel
635 x 502mm (2ft 1in x 1ft 8in)

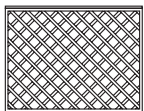

D-4PTB diamond planter base panel / dado panel
1245 x 965mm (4ft 1in x 3ft 2in)

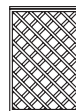

D-2PTB diamond planter base panel / dado panel
635 x 965mm (2ft 1in x 3ft 2in)

D-4RB/R diamond drop curve panel
1245 x 1420mm (4ft 1in x 4ft 8in)

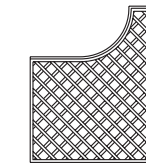
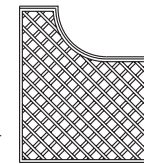

D-4RB/L diamond drop curve panel
1245 x 1420mm (4ft 1in x 4ft 8in)

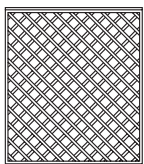

D-4TB diamond base panel
1245 x 1420mm (4ft 1in x 4ft 8in)

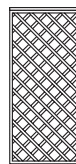

D-2TB diamond base panel
635 x 1420mm (2ft 1in x 4ft 8in)

D-4DB/R diamond drop curve panel
1245 x 1420mm (4ft 1in x 4ft 8in)

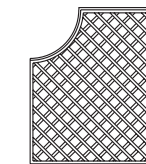
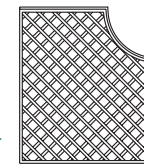

D-4DB/L diamond drop curve panel
1245 x 1420mm (4ft 1in x 4ft 8in)

NB. Measurements are shown width x height x depth (where appropriate)

TRELLIS COMPONENTS DIAMOND MODULAR

100mm (4in) centres diamond overlap & 76mm (3in) square overlap

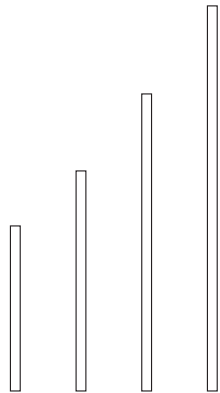

PO/90/1.5 89mm section post
89 x 1500 x 89mm (3 3/4in x 4ft 11in x 3 3/4in)

PO/90/2 89mm section post
89 x 2040 x 89mm (3 3/4in x 6ft 9in x 3 3/4in)

PO/90/2.7 89mm section post
89 x 2750 x 89mm (3 3/4in x 9ft x 3 3/4in)

PO/90/3.5 89mm section post
89 x 3500 x 89mm (3 3/4in x 11ft 6in x 3 3/4in)

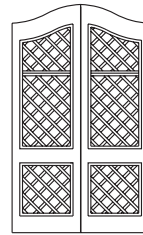

D-SG (pair) 4' diamond serpentine gates
(including standard hardware)
1240 x 2055 x 44mm
(4ft 1in x 6ft 9in x 1 3/4in)

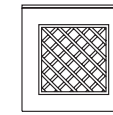

D-HG3 3' diamond hampton court gate
(including standard hardware)
940 x 965 x 44mm
(3ft 1in x 3ft 2in x 1 3/4in)



PC/90 post cap for PO/90
160 x 45 x 160mm
(6 1/2in x 2in x 6 1/2in)



AF/90/PC acorn finial and post cap for PO/90
160 x 205 x 160mm
(6 1/2in x 8in x 6 1/2in)



MF/90/PC mushroom finial and post cap for PO/90
160 x 126 x 160mm
(6 1/2in x 5in x 6 1/2in)



VF/90/PC vase finial and post cap for PO/90
160 x 246 x 160mm
(6 1/2in x 10in x 6 1/2in)



BF/90/PC ball finial and post cap for PO/90
160 x 170 x 160mm
(6 1/2in x 7in x 6 1/2in)

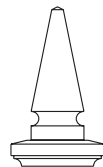

OF/90/PC obelisk finial and post cap for PO/90
160 x 275 x 160mm
(6 1/2in x 11in x 6 1/2in)

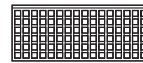

4TT/3 header panel
76mm overlapped
1245 x 502mm (4ft 1inx 1ft 8in)



2TT/3 header panel
76mm overlapped
635 x 502mm (2ft 1inx 1ft 8in)

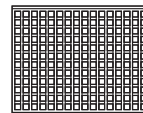

4PTB/3 planter base panel / dado panel
76mm overlapped
1245 x 965mm (4ft 1inx 3ft 2in)

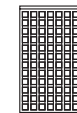

2PTB/3 planter base panel / dado panel
76mm overlapped
635 x 965mm (2ft 1inx 3ft 2in)

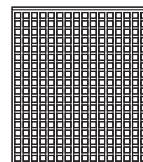

4TB/3 base panel
76mm overlapped
1245 x 1420mm (4ft 1inx 4ft 8in)

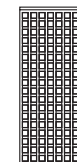

2TB/3 base panel
76mm overlapped
635 x 1420mm (2ft 1inx 4ft 8in)

NB. Measurements are shown width x height x depth (where appropriate)

TRELLIS SCHEMES DIAMOND MODULAR

100mm (4in) centres diamond overlap

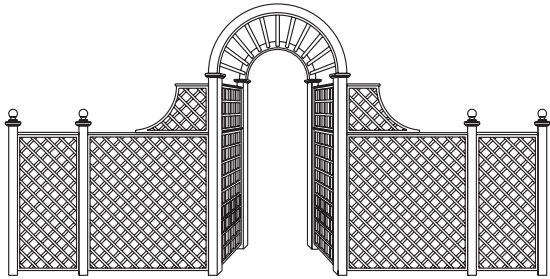

diamond rose arch screen 5.5m length
100mm (4in) centres diamond with rose arch

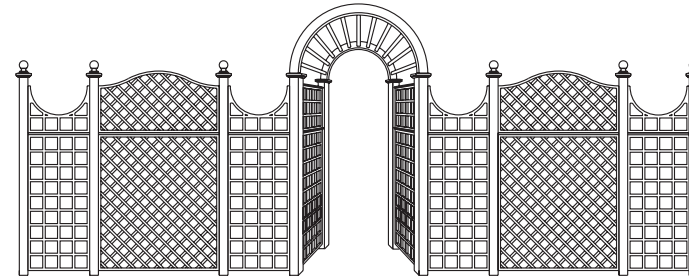

modular rose arch screen 7m length
100mm (4in) centres diamond with rose arch and 152mm (6in) centres square

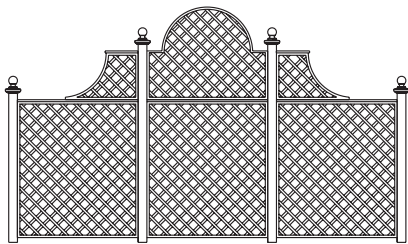

diamond drop curve screen 4m length
100mm (4in) centres diamond
24 x 11mm batten overlap

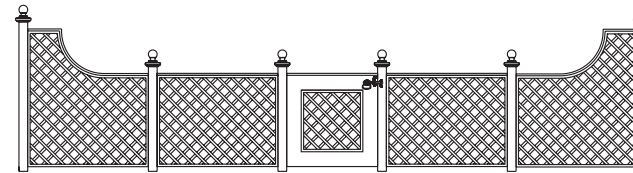

hampton court gate screen 6.5m length
100mm (4in) centres diamond with gate
24 x 11mm batten overlap

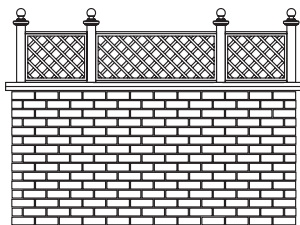

diamond trelliswork on a wall 2.9m length
(optional post shoes NOT included)
100mm (4in) centres diamond
24 x 11mm batten overlap

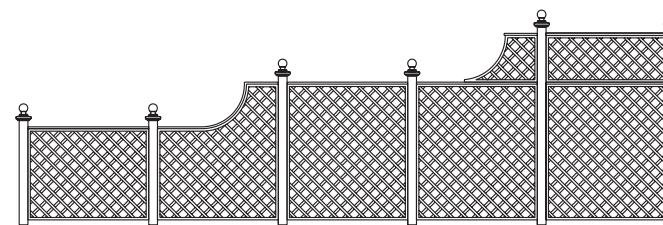

diamond panels showing height increase 6.8m length
100mm (4in) centres diamond
24 x 11mm batten overlap

NB. Measurements are shown width x height x depth (where appropriate)

TRADITIONAL TRELLIS

152mm (6in) centres square jointed panels

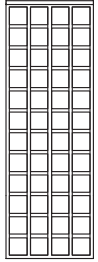

TR-6/2 trellis panel
635 x 1877mm (2ft 1in x 6ft 2in)

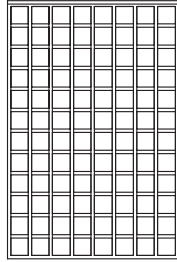

TR-6/4 trellis panel
1245 x 1877mm (4ft 1in x 6ft 2in)

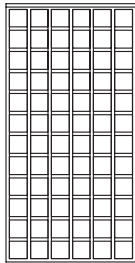

TR-6/3 trellis panel
939 x 1877mm (3ft 1in x 6ft 2in)

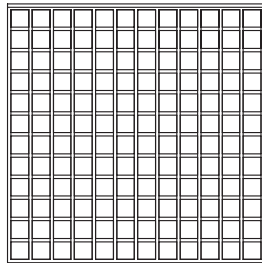

TR-6/6 trellis panel
1855 x 1877mm (6ft 1in x 6ft 2in)

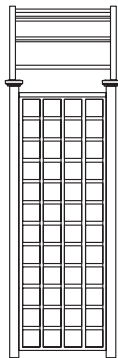
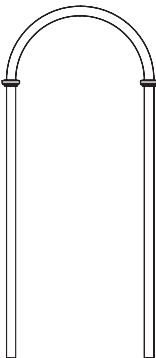

TR-3RA/C/PO 3' rose arch complete
1073 x 2556 x 771mm (3ft 6in x 8ft 5in x 2ft 6in)

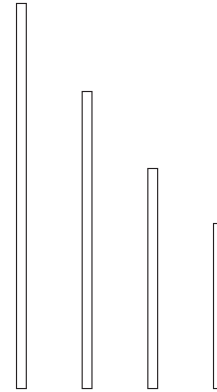

PO/70/3 68mm section post
68 x 68 x 3000mm (2 1/2in x 2 1/2in x 9ft 10in)

PO/70/2.5 68mm section post
68 x 68 x 2500mm (2 1/2in x 2 1/2in x 8ft 2in)

PO/70/2 68mm section post
68 x 68 x 2040mm (2 1/2in x 2 1/2in x 6ft 8in)

PO/70/1.5 68mm section post
68 x 68 x 1500mm (2 1/2in x 2 1/2in x 4ft 11in)

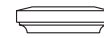

PC/70 post cap for PO/70
125 x 125 x 42mm
(5in x 5in x 1 1/2in)



AF/70/PC acorn finial and post cap for PO/70
125 x 125 x 155mm
(5in x 5in x 6in)



MF/70/PC mushroom finial and post cap for PO/70
125 x 125 x 105mm
(5in x 5in x 4in)



VF/70/PC vase finial and post cap for PO/70
125 x 125 x 202mm
(5in x 5in x 8in)



BF/70/PC ball finial and post cap for PO/70
125 x 125 x 130mm
(5in x 5in x 5in)

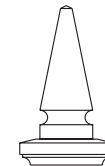

OF/70/PC obelisk finial and post cap for PO/70
125 x 125 x 210mm
(5in x 5in x 8in)

NB. Measurements are shown width x height x depth (where appropriate)

WILLOW WEAVE PANELS

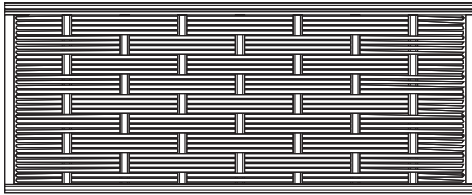

4/TW willow weave header panel
1245 x 502mm (4ft 1in x 1ft 8in)

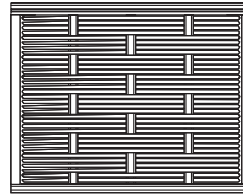

2/TW willow weave header panel
635 x 502mm (2ft 1in x 1ft 8in)

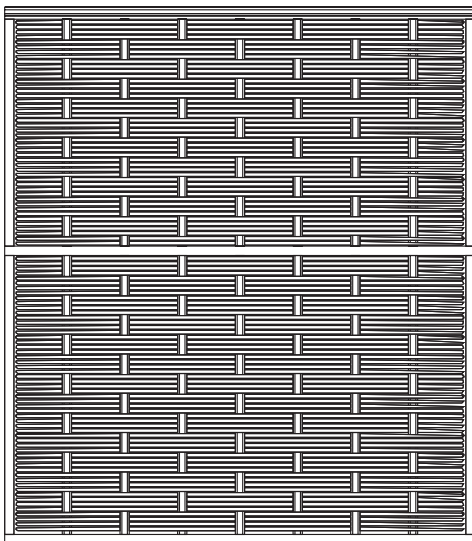

4/BW willow weave base panel
1245 x 1420mm (4ft 1in x 4ft 8in)

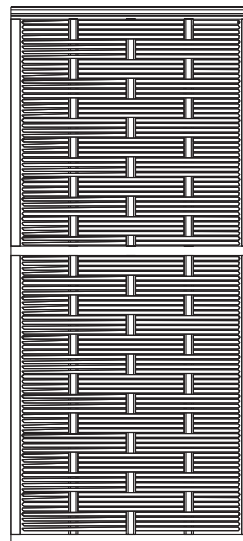

2/BW willow weave base panel
635 x 1420mm (2ft 1in x 4ft 8in)

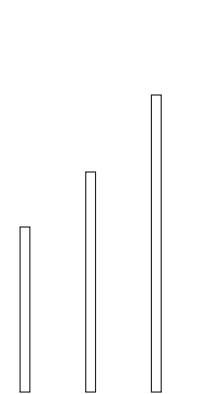

PO/90/1.5 89mm section post
89 x 1500 x 89mm (3 3/4in x 4ft 11in x 3 3/4in)

PO/90/2 89mm section post
89 x 2040 x 89mm (3 3/4in x 6ft 9in x 3 3/4in)

PO/90/2.7 89mm section post
89 x 2750 x 89mm (3 3/4in x 9ft x 3 3/4in)

PO/90/3.5 89mm section post
89 x 3500 x 89mm (3 3/4in x 11ft 6in x 3 3/4in)



PC/90 post cap for PO/90
160 x 45 x 160mm
(6 1/2in x 2in x 6 1/2in)



AF/90/PC acorn finial and post cap for PO/90
160 x 205 x 160mm
(6 1/2in x 8in x 6 1/2in)



MF/90/PC mushroom finial and post cap for PO/90
160 x 126 x 160mm
(6 1/2in x 5in x 6 1/2in)



VF/90/PC vase finial and post cap for PO/90
160 x 246 x 160mm
(6 1/2in x 10in x 6 1/2in)



BF/90/PC ball finial and post cap for PO/90
160 x 170 x 160mm
(6 1/2in x 7in x 6 1/2in)

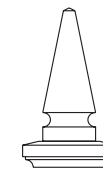

OF/90/PC obelisk finial and post cap for PO/90
160 x 275 x 160mm
(6 1/2in x 11in x 6 1/2in)

NB. Measurements are shown width x height x depth (where appropriate)

MODULAR ROSE ARCHES

modular rose arches come complete with PO/90/2.7 posts and 2TT & 2TB trellis side panels

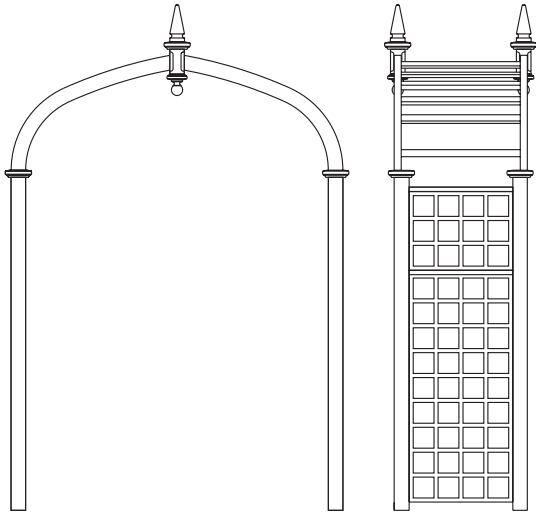

6 TGA/C/PO
6ft tudor gothic rose arch complete
 height including arch 3099mm (10ft 2in)
 2033 x 2040 x 813mm (6ft 8in x 6ft 8in x 2ft 8in)

4 TGA/C/PO
4ft tudor gothic rose arch complete
 height including arch 2882mm (9ft 5in)
 1423 x 2040 x 813mm (4ft 8in x 6ft 8in x 2ft 8in)

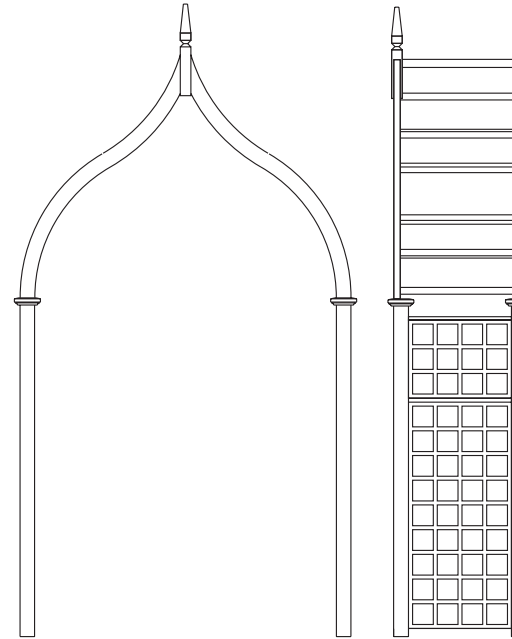

6 GRA/C/PO
6ft gothic rose arch complete
 height including arch 3891mm (12ft 9in)
 2033 x 2040 x 813mm (6ft 8in x 6ft 8in x 2ft 8in)

4 GRA/C/PO
4ft gothic rose arch complete
 height including arch 3448mm (11ft 4in)
 1423 x 2040 x 813mm (4ft 8in x 6ft 8in x 2ft 8in)

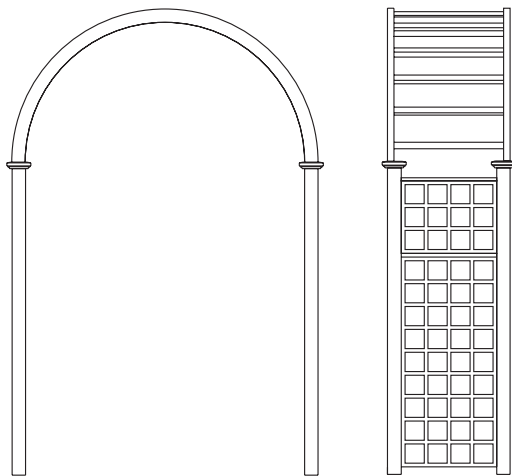

6 RA/C/PO
6ft classic rose arch complete
 height including arch 3101mm (10ft 2in)
 2033 x 2040 x 813mm (6ft 8in x 6ft 8in x 2ft 8in)

4 RA/C/PO
4ft classic rose arch complete
 height including arch 2795mm (9ft 2in)
 1423 x 2040 x 813mm (4ft 8in x 6ft 8in x 2ft 8in)

NB. Measurements are shown width x height x depth (where appropriate)

VERSAILLES PLANTERS

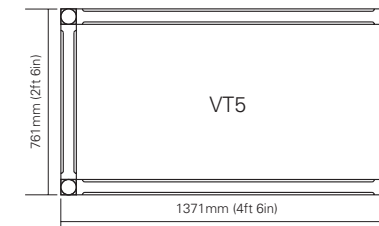
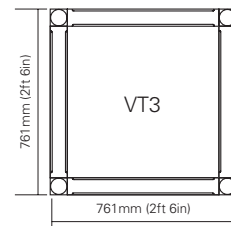
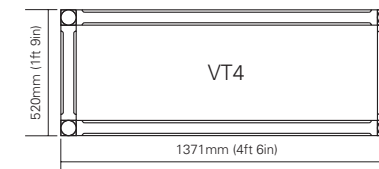
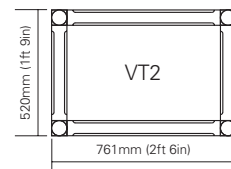
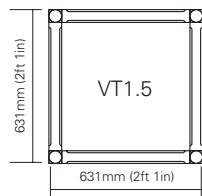
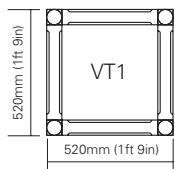
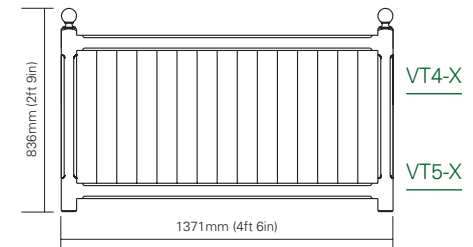
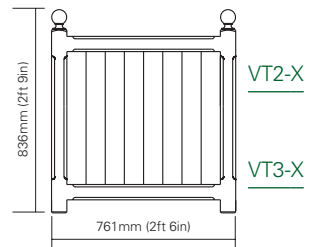
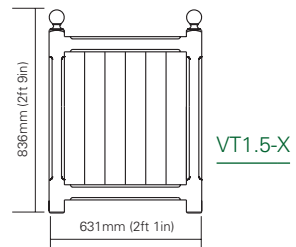
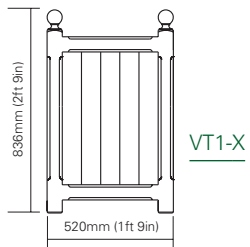
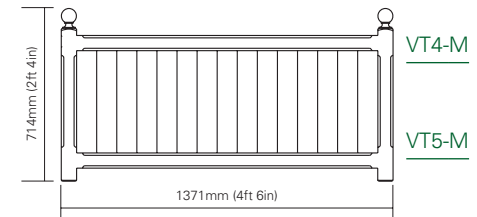
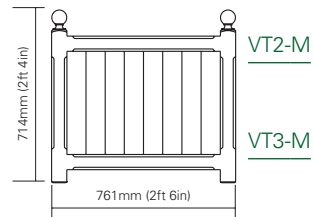
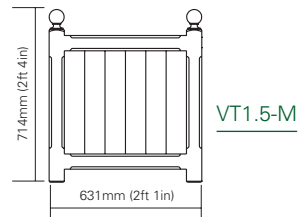
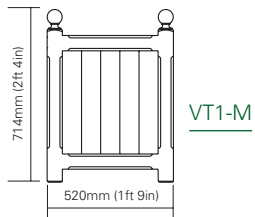
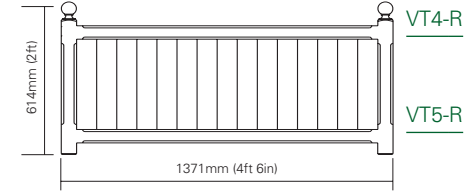
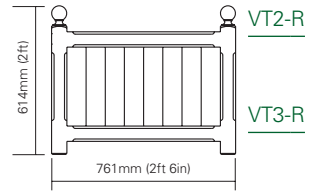
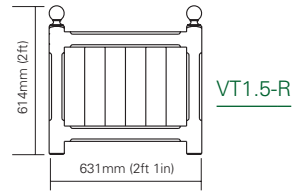
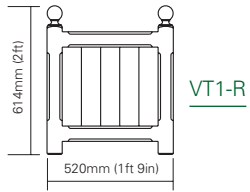

VT6-R
extra large shallow planter

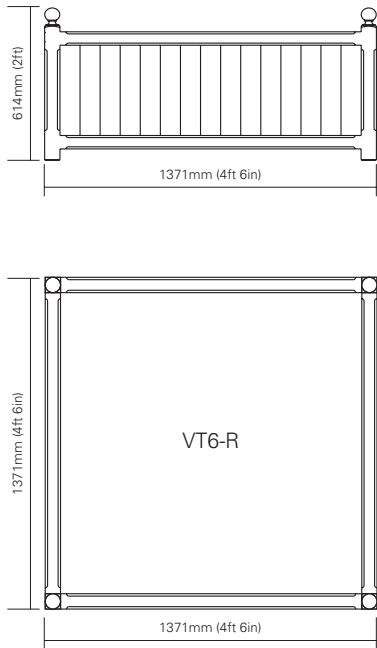

VTS-S
extra heavy tree planter

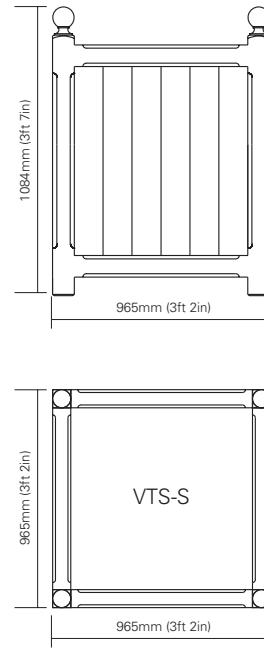

liners for versailles planters and planter supports

The number indicates the size and the final letter indicates the planter height. The same liner fits both 70 & 90 planter supports.

- L1-R* Planting volume 50 Ltrs
- L1.5-R* Planting volume 65 Ltrs
- L2-R* Planting volume 70 Ltrs
- L3-R* Planting volume 110 Ltrs
- L4-R* Planting volume 150 Ltrs
- L5-R Planting volume 220 Ltrs
- L6-R Planting volume 450 Ltrs
- L1-M Planting volume 65 Ltrs
- L1.5-M* Planting volume 90 Ltrs
- L2-M* Planting volume 95 Ltrs
- L3-M* Planting volume 150 Ltrs
- L4-M Planting volume 200 Ltrs
- L5-M Planting volume 300 Ltrs
- L1-X Planting volume 85 Ltrs
- L1.5-X* Planting volume 120 Ltrs
- L2-X* Planting volume 130 Ltrs
- L3-X* Planting volume 200 Ltrs
- L4-X Planting volume 270 Ltrs
- L5-X Planting volume 400 Ltrs
- LSS Planting volume 450 Ltrs

*Drop in liner (all others are built in)

R - planter

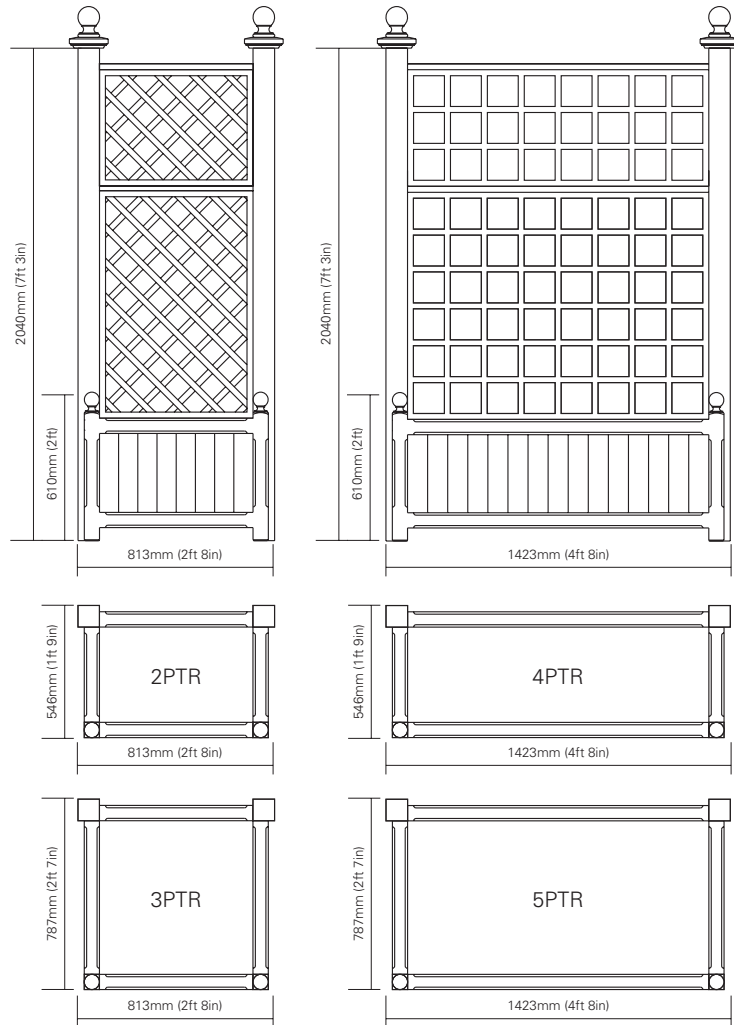

M - planter

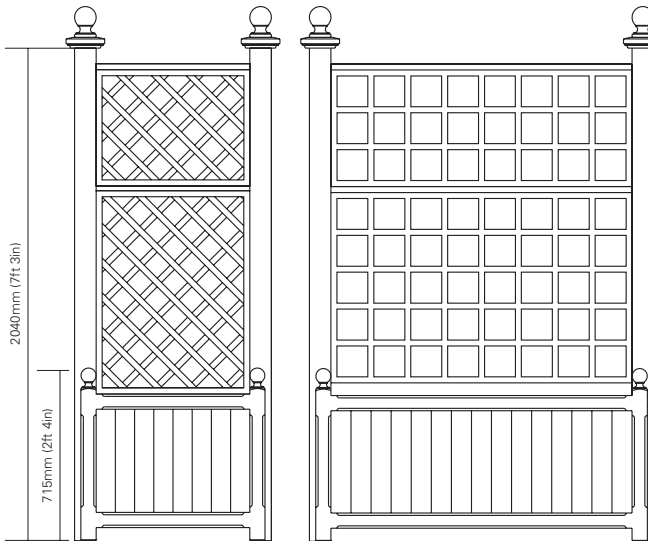

X - planter

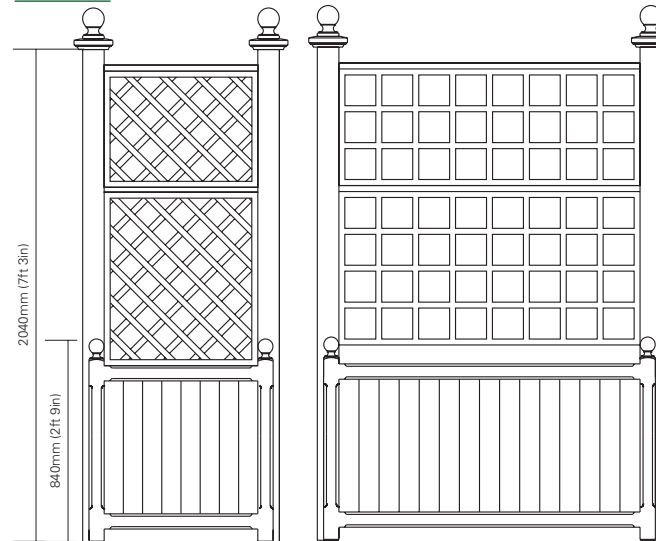

planter support units (excluding trellis, finials and liners)

R - planter height 610mm

2PTR-70	771 x 525 x 2040mm high
2PTR-90	813 x 546 x 2040mm high
3PTR-70	771 x 766 x 2040mm high
3PTR-90	813 x 787 x 2040mm high
4PTR-70	1381 x 525 x 2040mm high
4PTR-90	1423 x 546 x 2040mm high
5PTR-70	1381 x 770 x 2040mm high
5PTR-90	1423 x 787 x 2040mm high

M - planter height 715mm

2PTM-70	771 x 525 x 2040mm high
2PTM-90	813 x 546 x 2040mm high
3PTM-70	771 x 766 x 2040mm high
3PTM-90	813 x 787 x 2040mm high
4PTM-70	1381 x 525 x 2040mm high
4PTM-90	1423 x 546 x 2040mm high
5PTM-70	1381 x 766 x 2040mm high
5PTM-90	1423 x 787 x 2040mm high

X - planter height 840mm

2PTX-70	771 x 525 x 2040mm high
2PTX-90	813 x 546 x 2040mm high
3PTX-70	771 x 766 x 2040mm high
3PTX-90	813 x 787 x 2040mm high
4PTX-70	1381 x 525 x 2040mm high
4PTX-90	1423 x 546 x 2040mm high
5PTX-70	1381 x 766 x 2040mm high
5PTX-90	1423 x 787 x 2040mm high

WH/PT planter support integral wheel conversion (per pair)

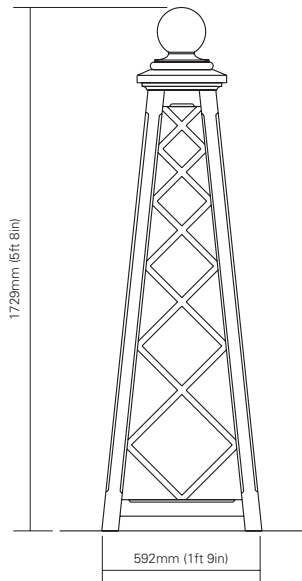

OC/OB/BF obelisk with ball finial

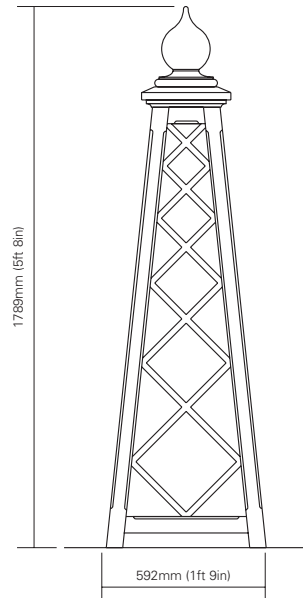

OC/OB/GF obelisk with gothic finial

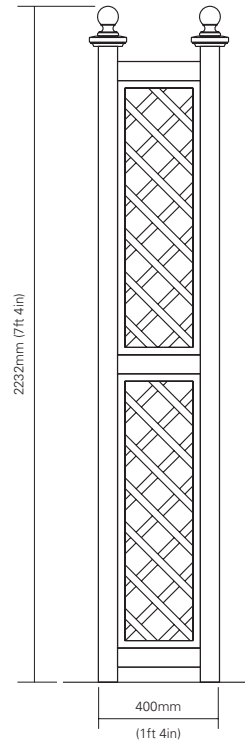

OC/OB/RC rose column

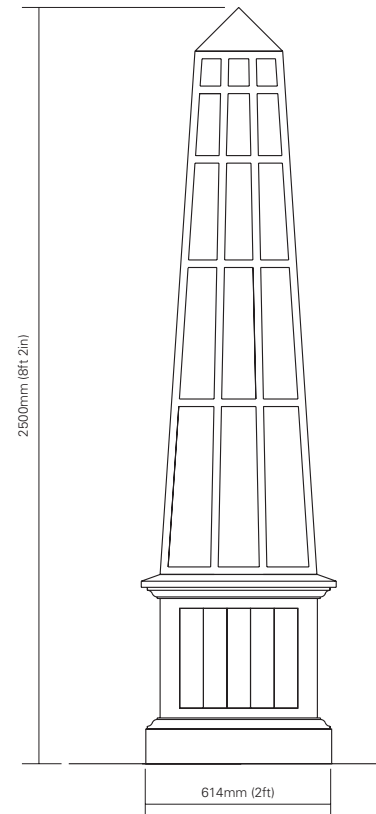

OC/OB/PL obelisk on a planter

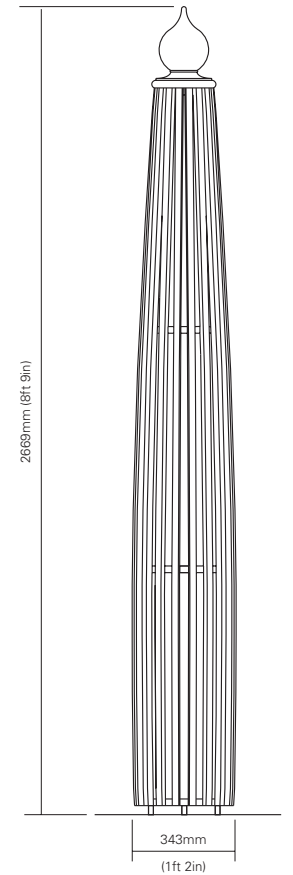

OC/OB/SP rose spire

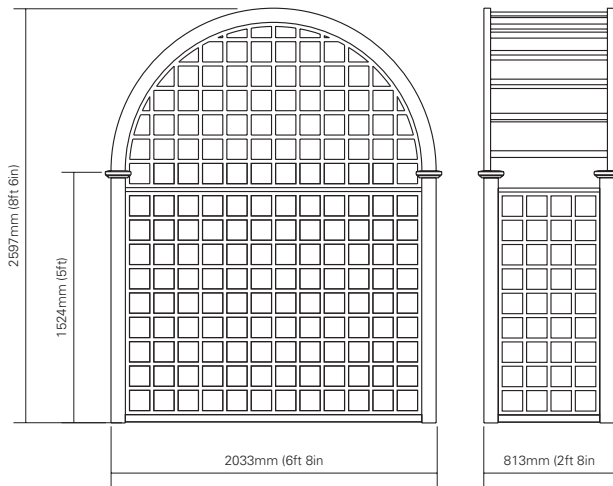

SA-SERP 6ft serpentine seat arbour with square trellis panels (shown)

SA-SERP/B 6ft serpentine seat arbour and Serpentine bench

D-SA-SERP 6ft serpentine seat arbour with diamond trellis panels

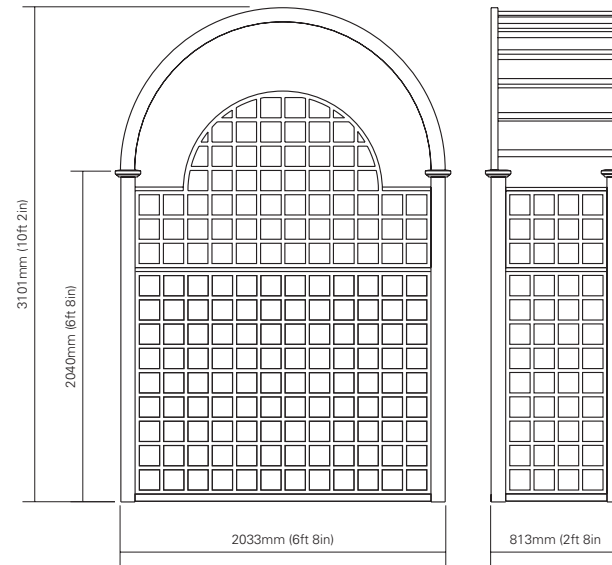

SA-CLAS 6ft classical seat arbour (shown)

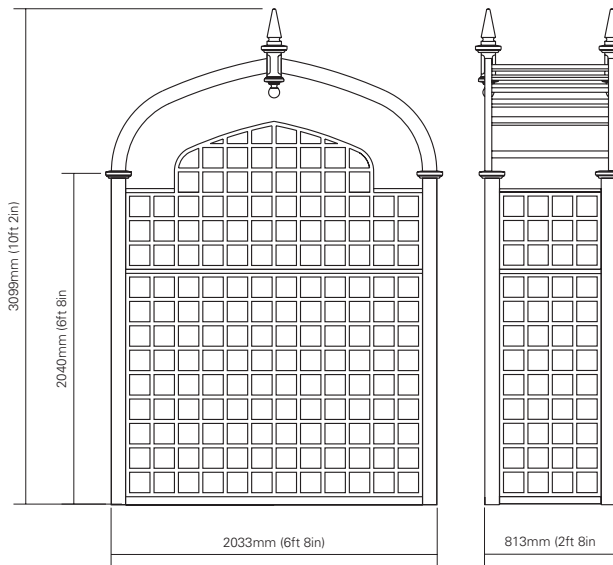

SA/TUD/GOTH 6ft tudor gothic seat arbour

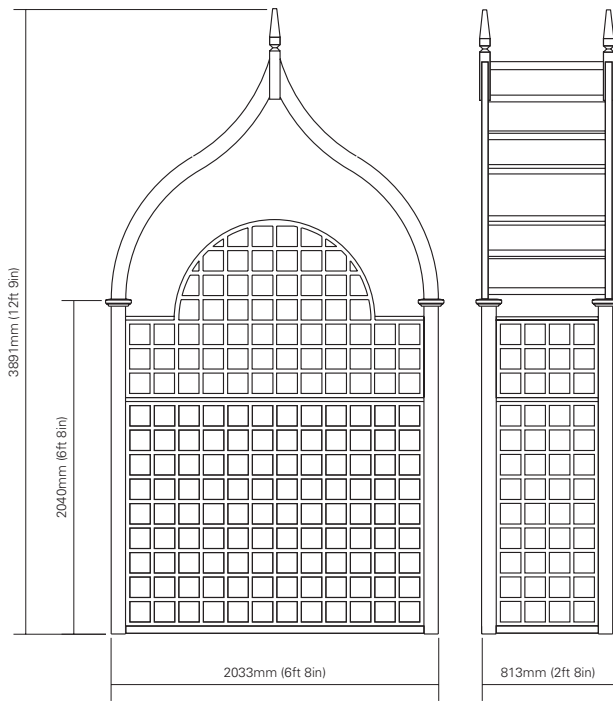

SA-GOTH 6ft gothic seat arbour

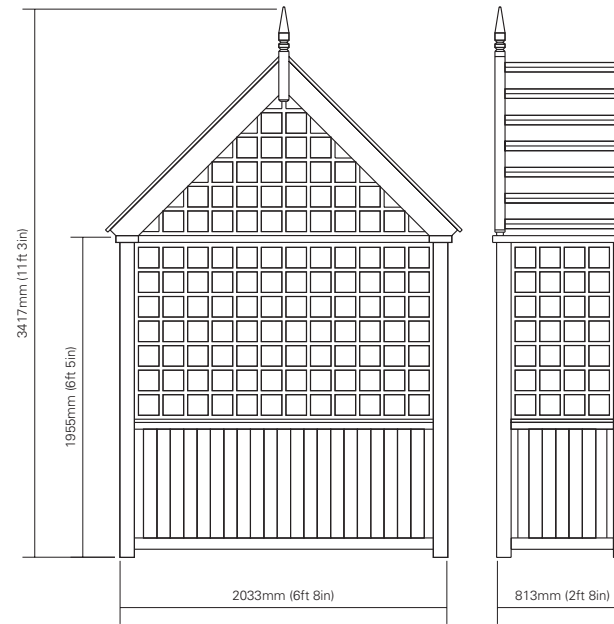

SA-VIC 6ft victorian seat arbour



SA-MIL milverton seat arbour (unpainted)

SA-MIL/P milverton seat arbour (painted)

BENCHES

manufactured in iroko: availability 21 days

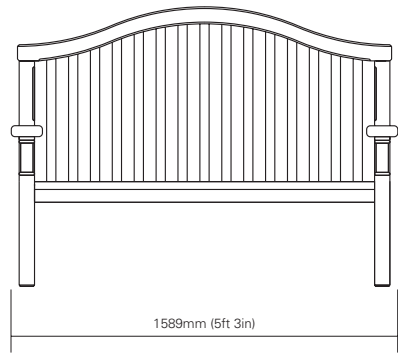
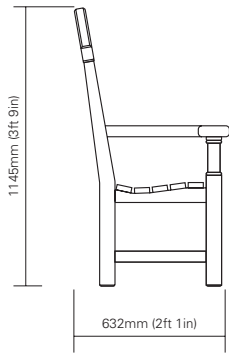

SERP serpentine bench

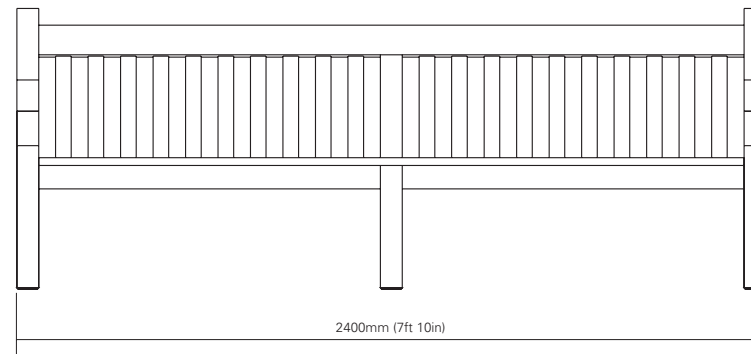
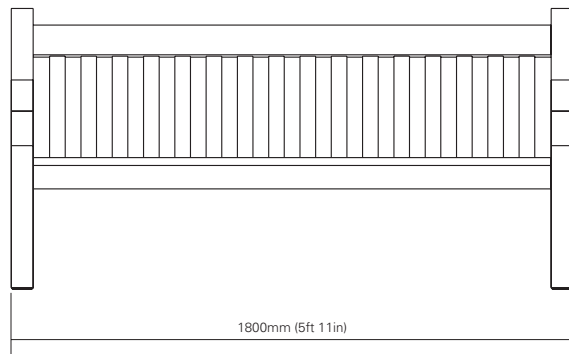
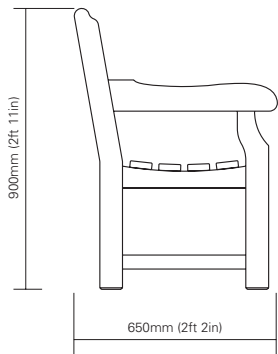

HURL/1800 hurlingham bench

HURL/2400 hurlingham bench

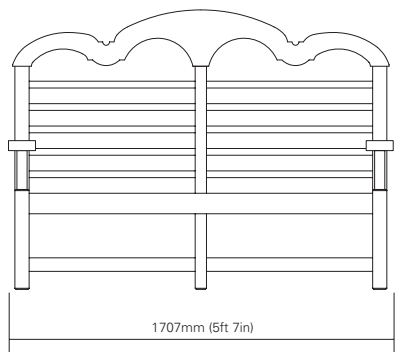
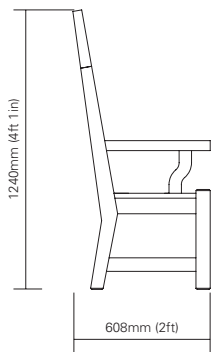

hestercombe 3 seater bench

CUSTOM BENCHES

manufactured in iroko: availability 8-10 weeks

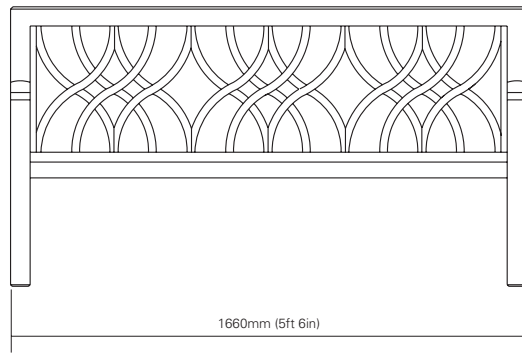
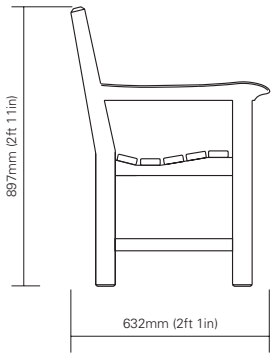

[sheraton 3 seater bench](#)

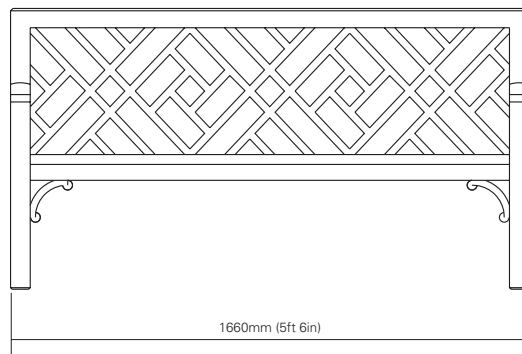
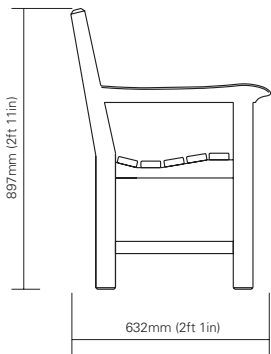

[chinese chippendale 3 seater bench](#)

[barrington armchair](#)

[chinese chippendale armchair](#)

[chinese chippendale 2 seater bench](#)

[sheraton armchair](#)

[sheraton 2 seater bench](#)

manufactured in teak: availability 8-10 weeks

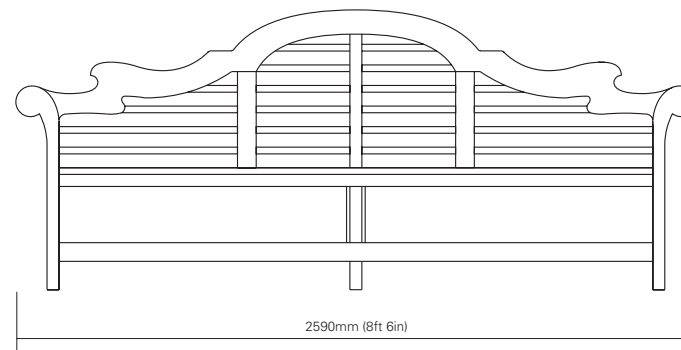
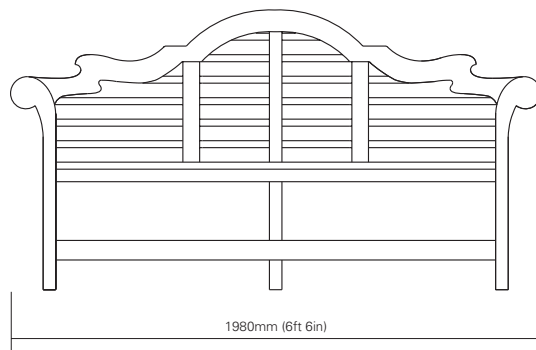
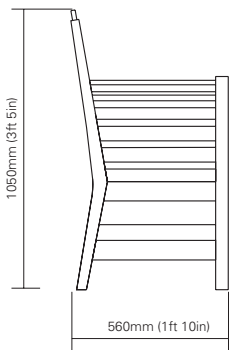

[lutyens bench medium](#)

[lutyens bench large](#)

CUSTOM BENCHES

manufactured in iroko: availability 8-10 weeks

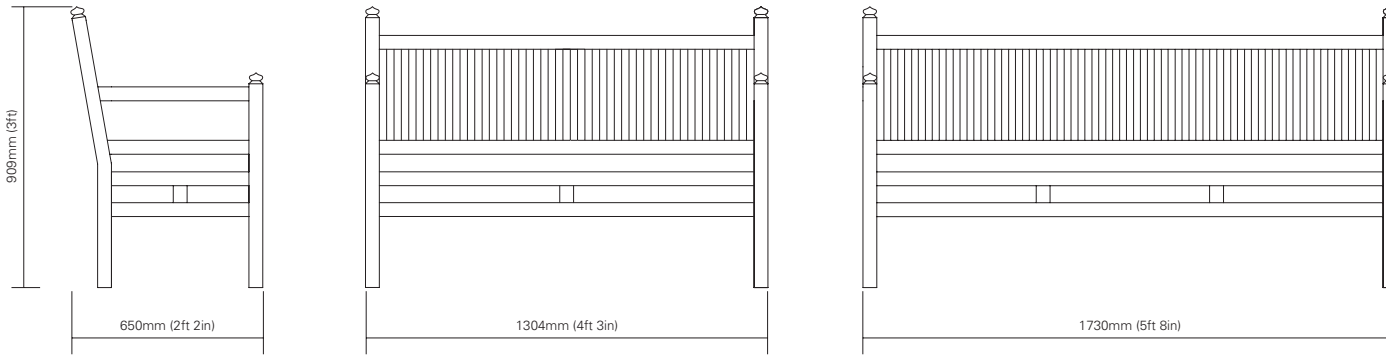

[barrington 2 seater bench](#)

[barrington 3 seater bench](#)

MODULAR COMPOSITE TIMBER & STEEL STEPPING PADS

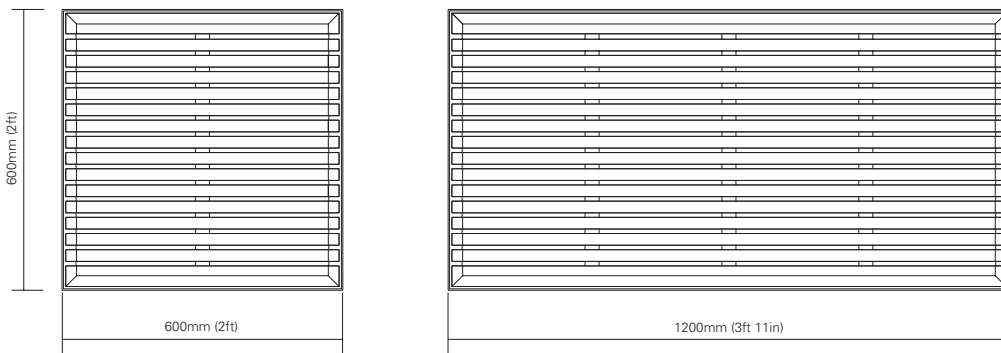

[nomad 2/2](#)

[nomad 2/4](#)

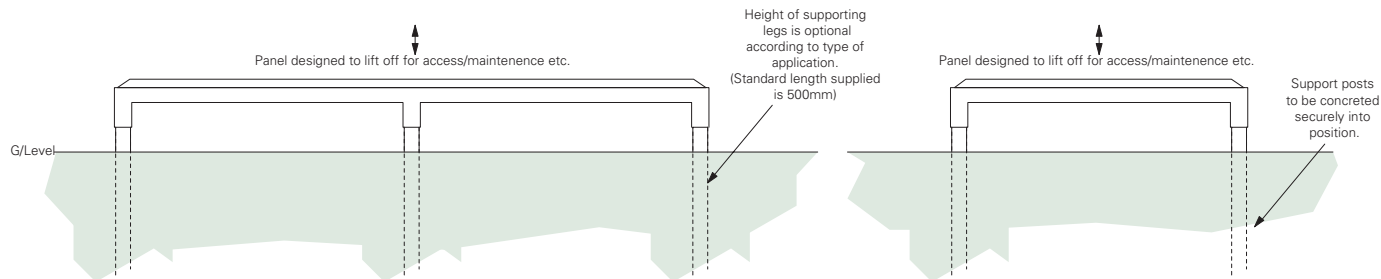

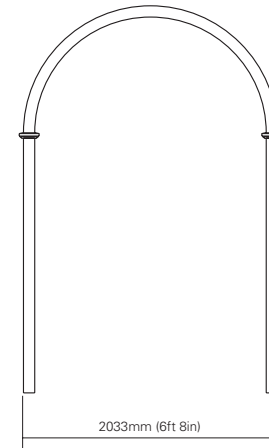
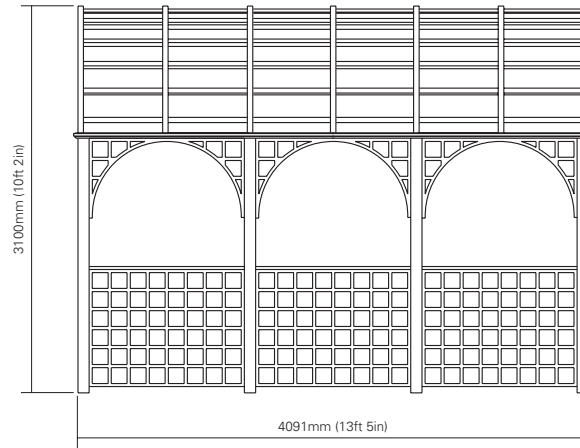
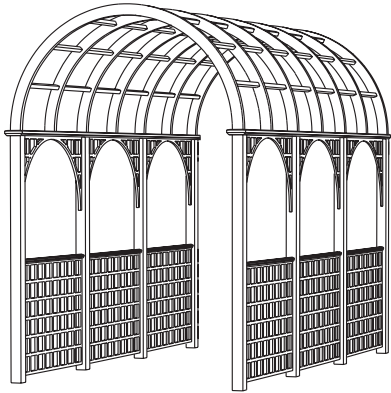

tunnel arbour

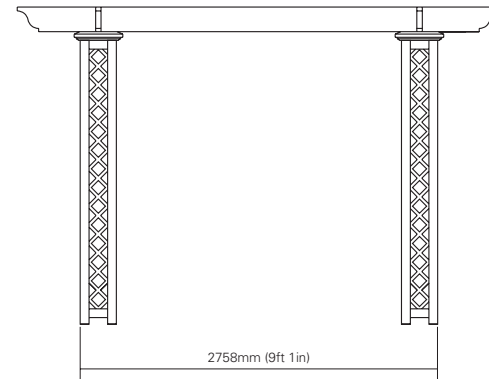
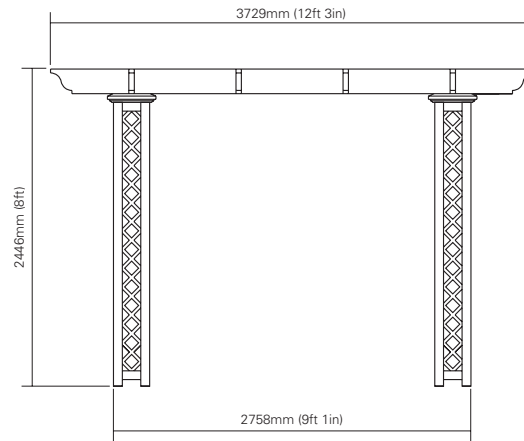
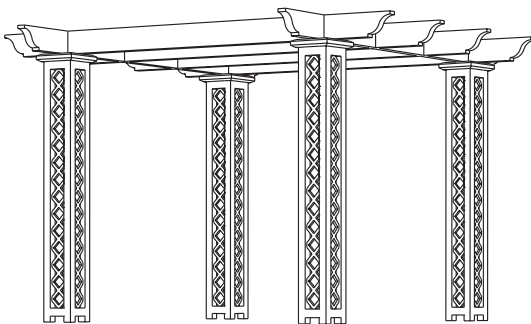

pergola with diamond trellis columns

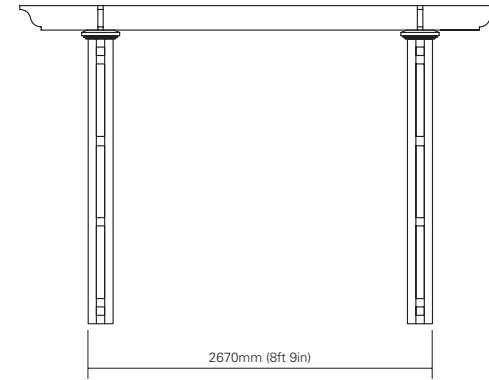
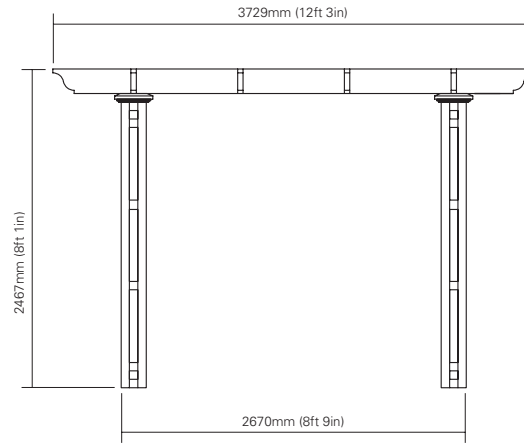
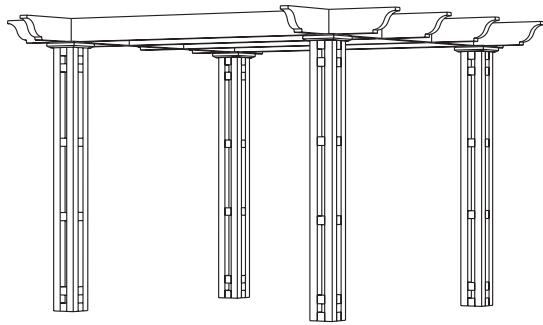

pergola with boxed trellis columns

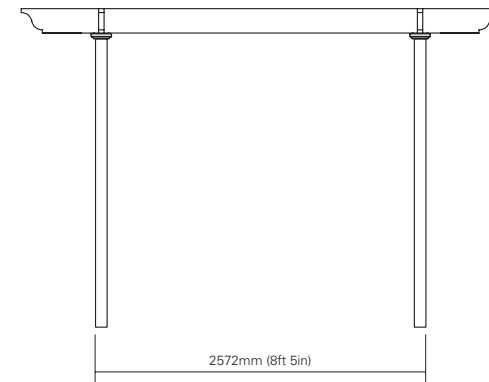
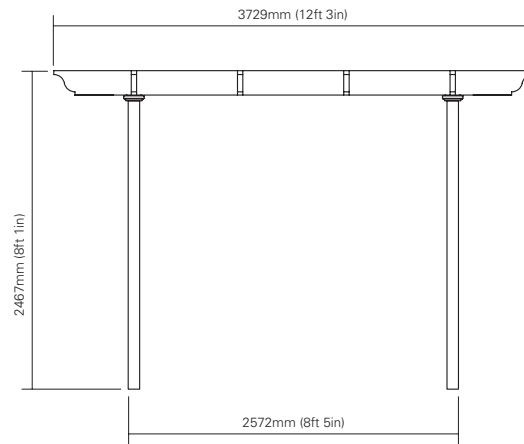
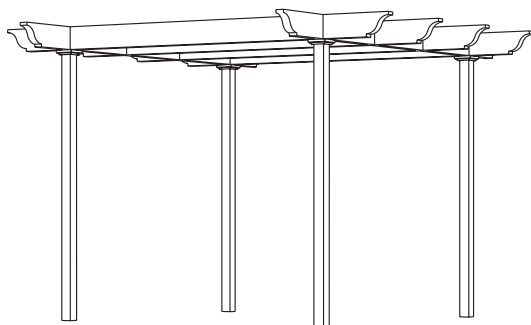

pergola with solid posts

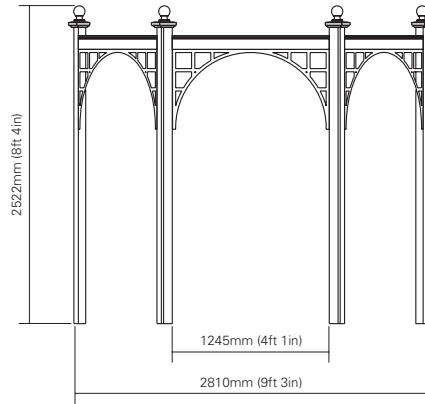
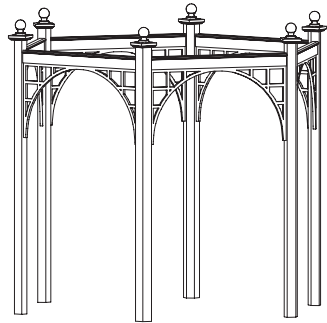

classical hexagonal pergola

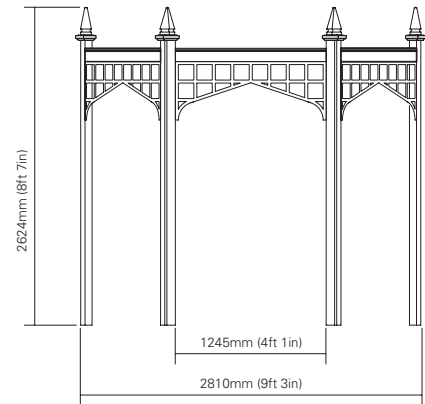
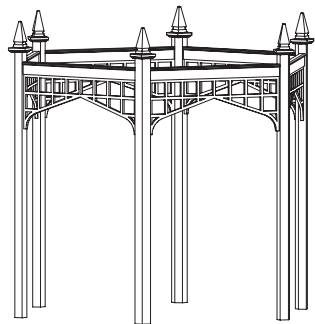

gothic hexagonal pergola

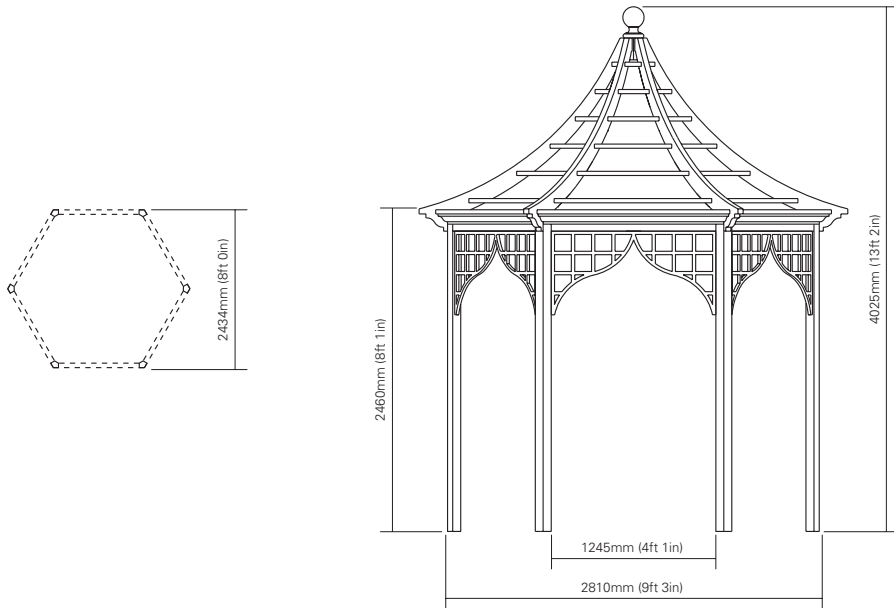

Fig.A
hexagonal trellis roof gazebo with gothic arches
(shown)

Fig.AA
hexagonal GRP (fibreglass) roof gazebo with gothic arches

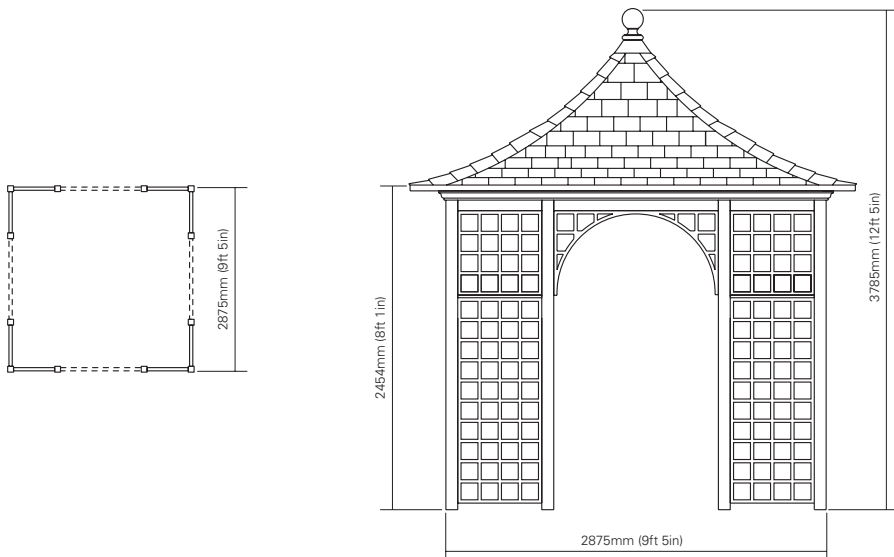

Fig.B
square shingle roof gazebo with four open faces
and arches flanked by full height trellis panels

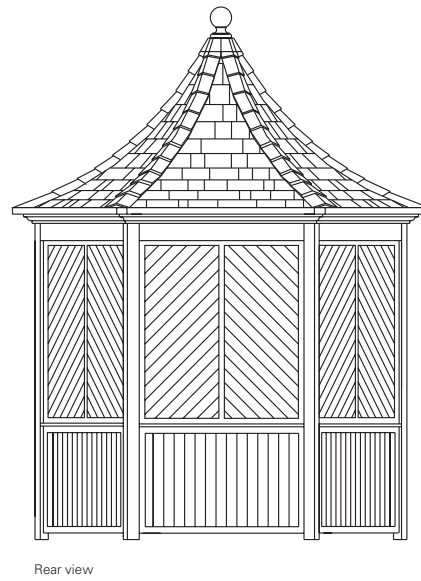
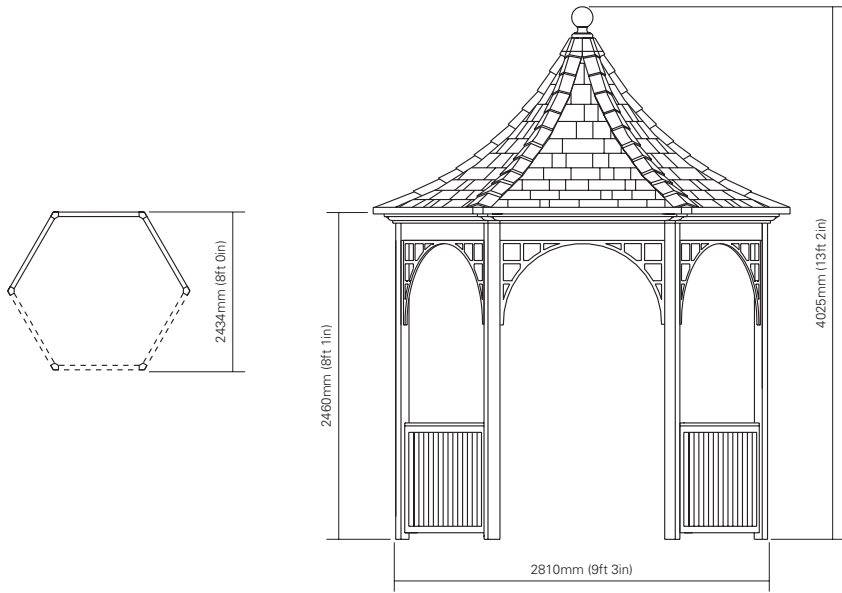

Fig.C
hexagonal shingle roof gazebo with three faces boarded,
front open with trellis arches and boarded dado panels

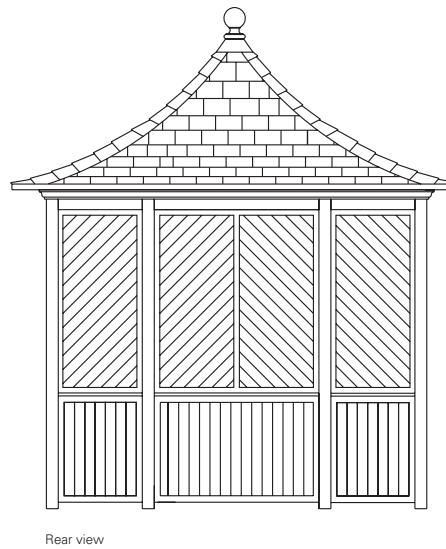
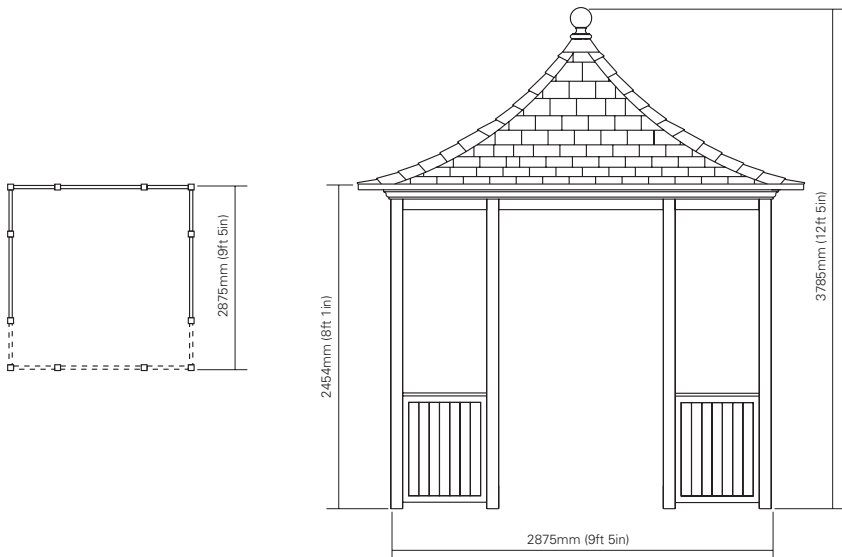

Fig.D
square shingle roof gazebo with boarded sides and back,
front open with boarded dado panels

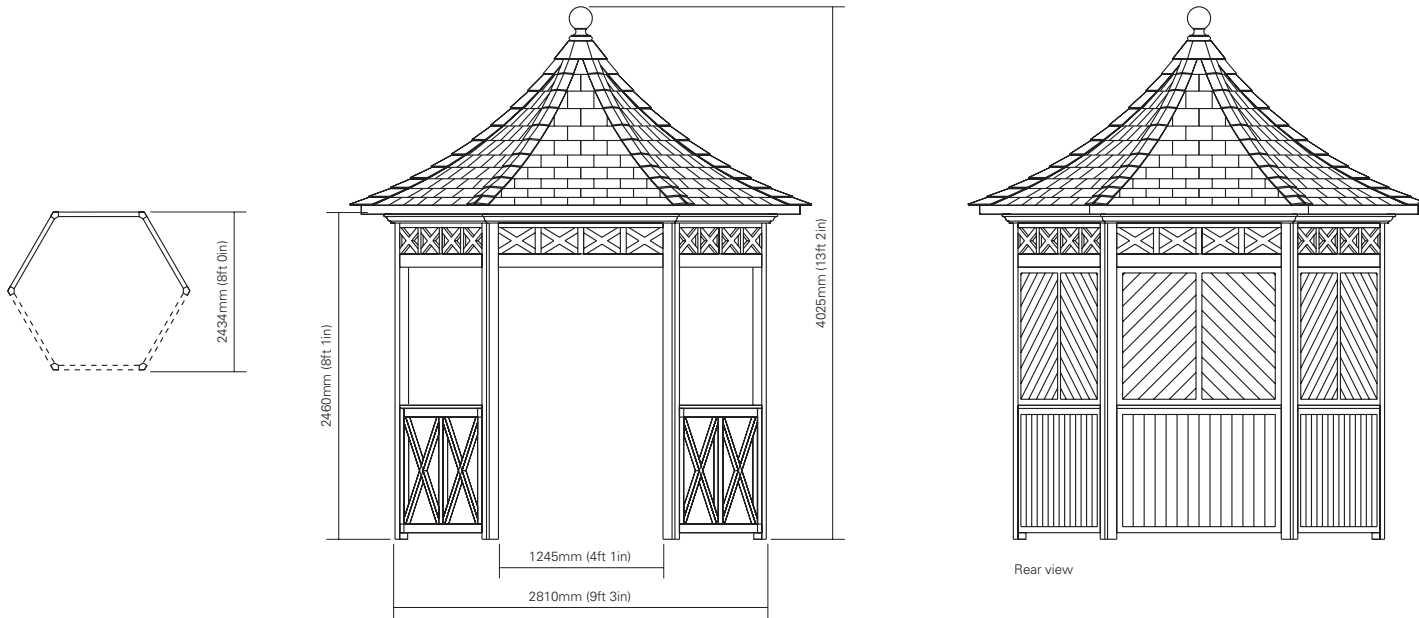

Fig.E
hexagonal regency style shingle roof gazebo
with boarded sides and back, front open with
cross-braced dado panels

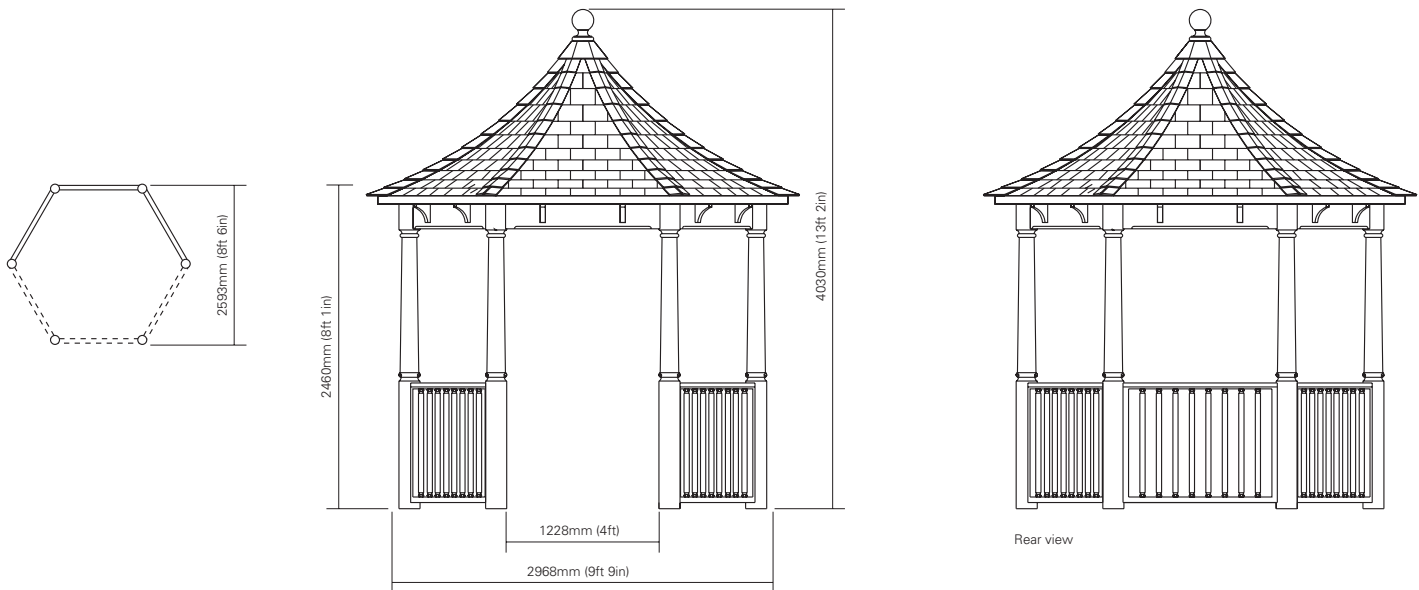

Fig.F
hexagonal shingle roof gazebo with
tapered columns and dado railing panels

GATES

Gates can be supplied for automation.

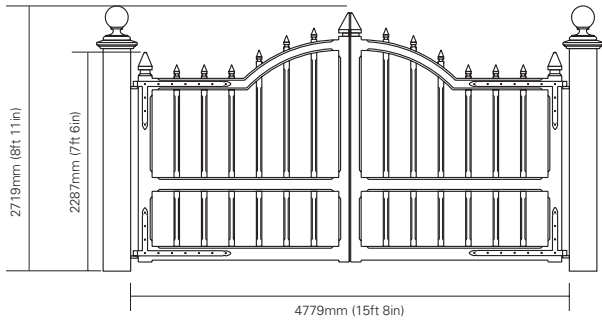

Fig.A entrance gates

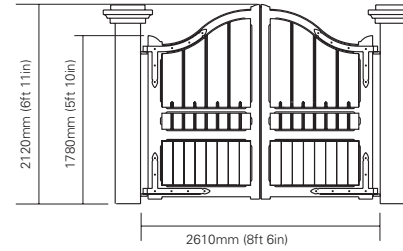

Fig.B serpentine gates with steel bars

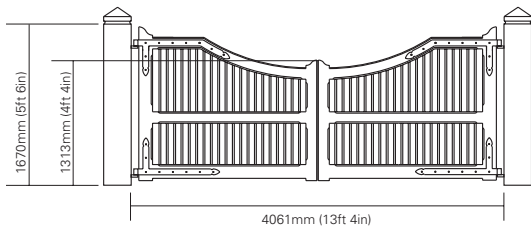

Fig.C entrance gates with steel bars

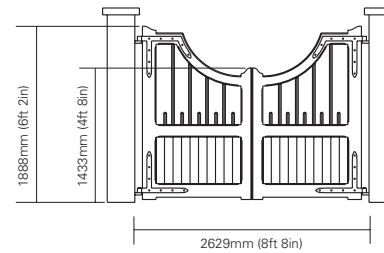

Fig.D lodge gates

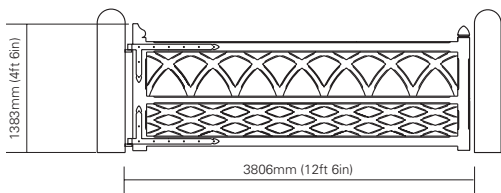

Fig.E victorian lodge gate

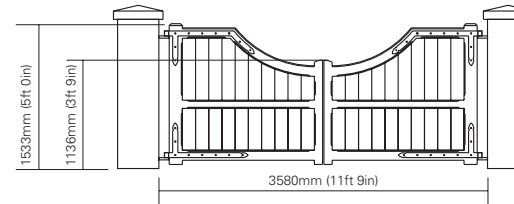

Fig.F close boarded gates

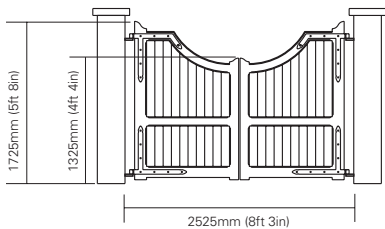

Fig.G close boarded gates

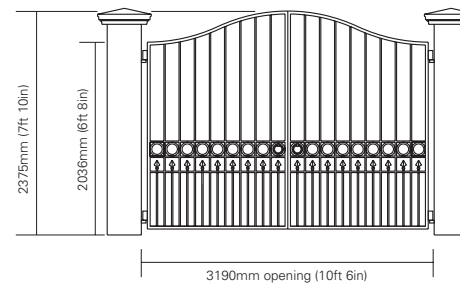
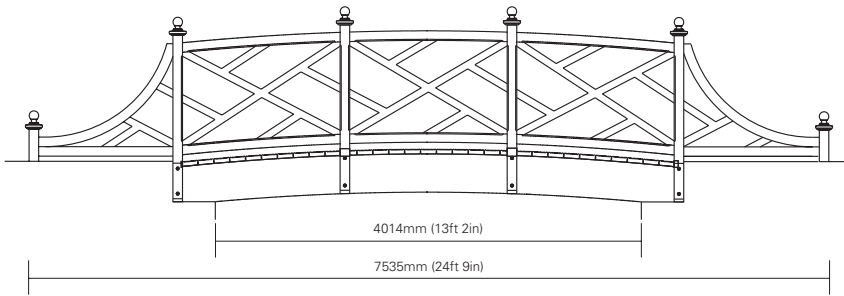
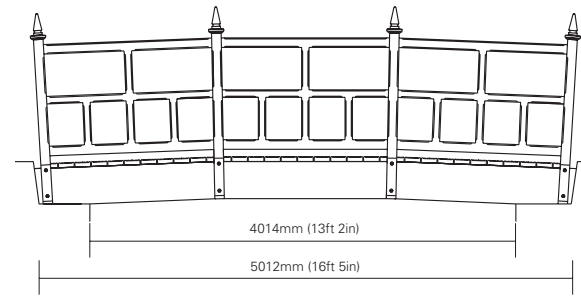

Fig.H steel serpentine entrance gates

ORNAMENTAL BRIDGES



chinese chippendale bridge



japanese bridge

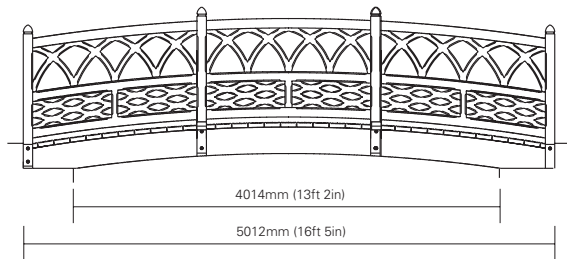

gothic bridge

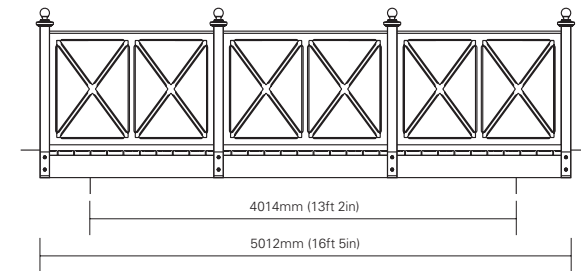

regency style bridge (straight)

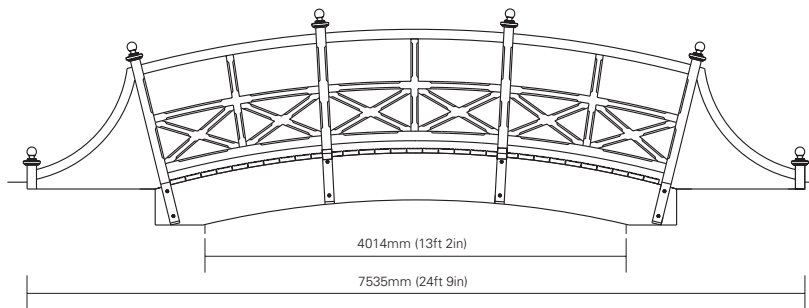

regency style bridge (curved)